

**GB**

**IMPELLER/PUMP VERSION : SPARE PARTS LIST**

**F**







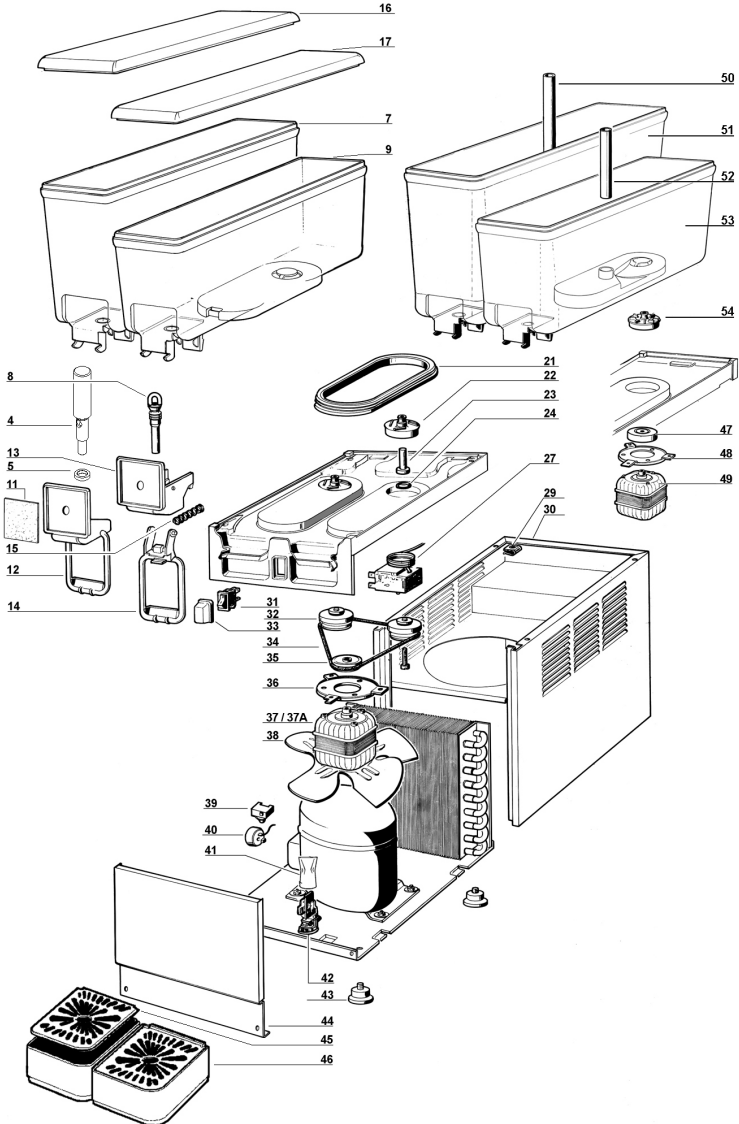





**VERSION IMPELLER/PUMP : LISTE DES PIECES DE RECHANGE**

**E**

**VERSIÓN DE IMPELLER / PUMP : DESCRIPCIÓN PIEZAS DE REPUESTO**



# Arctic Compact 5-8 UL

4	<b>22800-21903</b>	Faucet piston	Piston du robinet	Pistón del grifo
5	<b>10028-02503</b>	Faucet gasket	Joint du robinet	Junta del grifo
7	<b>22900-02010</b>	8 lt bowl	Réservoir 8 lt	Contenedor 8 lt
8	<b>21703-00000</b>	Pinch tube	Tuyau du robinet	Goma de grifo
9	<b>22900-01910</b>	5 lt bowl	Réservoir 5 lt	Contenedor 5 lt
11	<b>10029-00020</b>	Picture	Photo	Fotografía
12	<b>22900-00500</b>	Push handle	Levier du robinet	Palanca de mando grifo
13	<b>22900-00800</b>	Faucet cover	Couvercle du robinet	Cubre grifo
14	<b>22900-00501</b>	Push handle	Levier de débit	Palanca de mando grifo
15	<b>22800-02600</b>	Faucet spring	Ressort du robinet	Muelle grifo
16	<b>22900-01300</b>	8 lt bowl cover	Couvercle réservoir 8 lt	Tapa contenedor 8 lt
17	<b>22900-01300</b>	5 lt bowl cover	Couvercle réservoir 5 lt	Tapa contenedor 5 lt
21	<b>22800-17200</b>	Bowl gasket	Joint du réservoir	Turba contenedor
22	<b>33900-01201</b>	Impeller	Turbine de la pompe	Turbina bomba
23	<b>22900-00600</b>	Central pivot	Pivot central	Pivote central
24	<b>22040-00000</b>	Central pivot OR	OR du pivot central	OR del pivote central
27	<b>21087-00000</b>	Thermostat	Thermostat	Termostato
29	<b>10554-45000</b>	Clip	Clip	Clip
30a		Cabinet	Carrosserie	Caja
30b		White cabinet	Carrosserie blanc	Caja blanco
31	<b>21125-00000</b>	Switch	Interrupteur	Interruptor
32	<b>33900-01052</b>	Pulley, magnet and spacer assembly	Ensemble poulie, aimant et entretoise	Polea con magneto y distancial
33	<b>22800-05100</b>	Switch cap	Capuchon interrupteur	Protección interruptor
34	<b>22900-03602</b>	Belt	Courroie	Correa
35	<b>22800-02201</b>	Driving pulley	Poulie motrice	Polea motora
36	<b>22800-04800</b>	Motor bracket	Support du moteur	Placa soporte motor
37		Fan/pump motor for 1 bowl	Moteur ventilateur/pompe pour 1 réservoir	Motor ventilador/bomba por 1 contenedor
37A		Fan/pump motor for 2, 4 bowls	Moteur ventilateur/pompe pour 2, 4 réservoir	Motor ventilador/bomba por 2, 4 contenedor
38		Fan	Hélice	Aspas
39	<b>**</b>	Relay	Relais	Relé
40	<b>**</b>	Overload protector	Protège moteur	Guardamotor
41	<b>22800-12700</b>	Terminal block cover	Protection borne	Protección pasacable
42	<b>22800-05500</b>	Terminal block with cable clamp	Borne et fixage du câble	Pasacable
43	<b>22800-10000</b>	Rubber leg	Petit pied	Pie nivelador
44a		Dispensing side panel	Panneau côté robinet	Panel lado grifo
44b		White dispensing side panel	Panneau côté robinet blanc	Panel lado grifo blanco
45a		Drip tray cover	Couvercle tiroir égouttoir	Rejilla cajón
45b		White drip tray cover	Couvercle tiroir égouttoir blanc	Rejilla cajón blanco
46a		Drip tray	Tiroir égouttoir	Cajón recoge-gotas
46b		White drip tray	Tiroir égouttoir blanc	Cajón recoge-gotas blanco
47	<b>33800-00803</b>	Motor magnet for 1, 3 bowls	Aimant du moteur pour 1, 3 réservoir	Embrague magnetico por 1, 3 contenedor
48	<b>22800-04800</b>	Motor bracket	Support du moteur	Placa soporte motor
49		Pump motor 3 bowls	Moteur de la pompe 3 réservoir	Motor bomba por 3 contenedor
50	<b>22900-00203</b>	8lt Spray tube	Tube refoulement pompe 8lt	Tubo bomba para contenedor 8 l
51	<b>22900-02000</b>	8 lt bowl	Réservoir 8 lt	Contenedor 8 l linea P
52	<b>22900-00202</b>	5lt Spray tube	Tube refoulement pompe 5lt	Tubo bomba para contenedor 5 l
53	<b>22900-01900</b>	5 lt bowl	Réservoir 5 lt	Contenedor 5 l linea P

# Arctic Compact 5-8 UL

54 ○○○ Pump impeller for 5-8lt

Turbine de la pompe 5-8lt

Turbina bomba linea P

○○○□□□ See table

\*\*\* Please order what printed on piece

Voir tableau

Mentionner indicatif imprimé sur la pièce

Ver tabla

Pedir com la identificación marcada en la pieza

○○○

	230-240V 50Hz	115V 60Hz	220V 60Hz
37	22800-18980	22800-18981	22800-18982
37A	22900-03010	22900-03011	22900-03012
49	22800-04705	22800-04706	22800-04708
54	33900-01204	33900-01205	33900-01205

□□□

	1/..	2/..	3/..	4/..
30a	22900-03210	22900-03211	22900-03212	22900-03213
30b	22911-03210	22911-03211	22911-03212	22911-03213
38	22900-00403	22900-00401	22900-00401	22900-00401
44a	22900-03110	22900-03111	22900-03112	22900-03113
44b	-	22900-03121	-	-
45a	22800-00500	22800-00510	22800-00510	22800-00510
45b	22800-00561	22800-00562	22800-00562	22800-00562
46a	22800-00602	22800-00611	22800-00611	22800-00611
46b	22800-00601	22800-00662	22800-00662	22800-00662

**GB**

**AGITATOR VERSION : SPARE PARTS LIST**

**F**







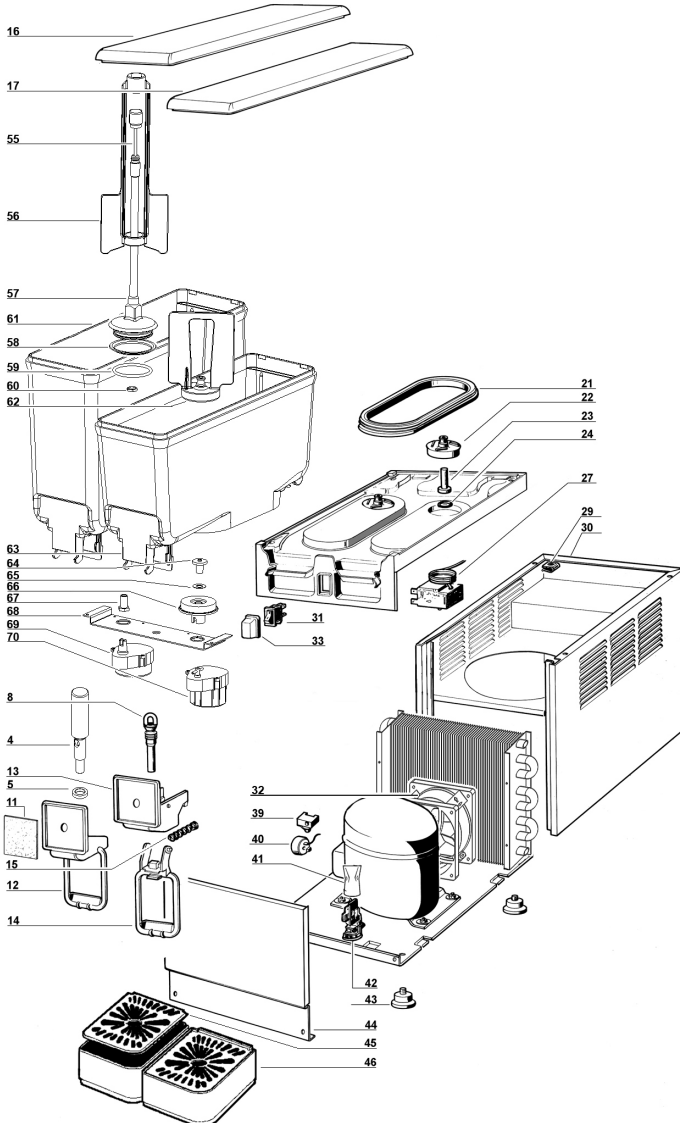





**VERSION SHAKER : LISTE DES PIECES DE RECHANGE**

**E**

**VERSIÓN DE AGITATOR : DESCRIPCIÓN PIEZAS DE REPUESTO**



# Arctic Compact 5-8 UL

4	<b>22800-21903</b>	Faucet piston	Piston du robinet	Pistón del grifo
5	<b>10028-02503</b>	Faucet gasket	Joint du robinet	Junta del grifo
8	<b>21703-00000</b>	Pinch tube	Tuyau du robinet	Goma de grifo
11	<b>10029-00020</b>	Picture	Photo	Fotografía
12	<b>22900-00500</b>	Push handle	Lever du robinet	Placa de mando grifo
13	<b>22900-00800</b>	Faucet cover	Couvercle du robinet	Cubre grifo
14	<b>22900-00501</b>	Push handle	Lever de débit	Palanca de mando grifo
15	<b>22800-02600</b>	Faucet spring	Ressort du robinet	Muelle grifo
21	<b>22800-17200</b>	Bowl gasket	Joint du réservoir	Junta contenedor
22	<b>33900-01201</b>	Impeller	Turbine de la pompe	Turbina bomba
23	<b>22900-00600</b>	Central pivot	Pivot central	Pivote central
24	<b>22040-00000</b>	Central pivot OR	OR du pivot central	OR del pivote central
27	<b>21087-00000</b>	Thermostat	Thermostat	Termostato
29	<b>10554-45000</b>	Clip	Clip	Clip
30a		Cabinet	Carrosserie	Caja
30b		White cabinet	Carrosserie blanc	Caja blanco
31	<b>21125-00000</b>	Switch	Interrupteur	Interruptor
32		Fan motor	Moteur ventilateur	Motor ventilador
33	<b>22800-05100</b>	Switch cap	Capuchon interrupteur	Protección interruptor
39	<b>***</b>	Relay	Relais	Relé
40	<b>***</b>	Overload protector	Protège moteur	Guardamotor
41	<b>22800-12700</b>	Terminal block cover	Protection borne	Protección pasacable
42	<b>22800-05500</b>	Terminal block with cable clamp	Borne et fixation du câble	Pasacable
43	<b>22800-10000</b>	Rubber leg	Petit pied	Pie nivelador
44a		Dispensing side panel	Panneau côté robinet	Panel lado grifo
44b		White dispensing side panel	Panneau côté robinet blanc	Panel lado grifo blanco
45a		Drip tray cover	Couvercle tiroir égouttoir	Rejilla cajón
45b		White drip tray cover	Couvercle tiroir égouttoir blanc	Rejilla cajón blanco
46a		Drip tray	Tiroir égouttoir	Cajón recoge-gotas
46b		White drip tray	Tiroir égouttoir blanc	Cajón recoge-gotas blanco
55	<b>22900-05603</b>	Driving shaft 8lt	Arbre d'entraînement 8lt	Eje transmisión 8lt
56	<b>22900-05410</b>	Stirrer 8lt	Brasseur 8lt	Agitador 8lt
57	<b>22900-05503</b>	Central shaft 8lt	Arbre central 8lt	Eje central 8lt
58	<b>22900-05710</b>	Central shaft seal	Joint d'arbre centrale	Sello del eje central
59	<b>22900-05700</b>	Central shaft OR.	Joint OR pour arbre central	OR para eje central
60	<b>10533-01303</b>	brass nut	écrou en laiton	dado d'ottone
61	<b>22900-02020</b>	8 l bowl for stirrer	Cuve 8 l pour brasseur	Contenedor 8 l para agitador
62	<b>33900-01203</b>	Stirrer	Brasseur	Agitador
63	<b>22900-00020</b>	5 l bowl for stirrer	Cuve 5l pour brasseur	Contenedor 5 l para agitador
64	<b>22900-02502</b>	Central pivot	Pivot central	Pivote central
65	<b>22900-02503</b>	Washer	Rondelle	Arandela
66	<b>33900-01011</b>	Impeller mixer motor	Turbine de moteur du mélangeur	Turbina motor agitador
67	<b>22900-05800</b>	Threaded bolt shaft Central	Boulon fileté du Central	Perno roscado del eje central
68		Pump motor bracket	Support du moteur de la pompe	Placa soporte motor bomba
69		Mixer motor	Moteur du mélangeur	Motor agitador
70		Mixer motor	Moteur du mélangeur	Motor agitador

# Arctic Compact 5-8 UL

○○○□□□ See table

\*\*\* Please order what printed on piece

Voir tableau

Mentionner indicatif imprimé sur la pièce

Ver tabla

Pedir com la identificación marcada en la pieza

○○○

	230-240V 50Hz	115V 60Hz	220V 60Hz
32	22800-07600	22800-07601	22800-07600
69	33800-06700	33800-06701	33800-06700
70	22900-03500	22900-03501	22900-03500

□□□

	1/..	2/..	3/..	4/..
30a	22900-03210	22900-03211	22900-03212	22900-03213
30b	22911-03210	22911-03211	22911-03212	22911-03213
44a	22900-03110	22900-03111	22900-03112	22900-03113
44b	-	22900-03121	-	-
45a	22800-00500	22800-00510	22800-00510	22800-00510
45b	22800-00561	22800-00562	22800-00562	22800-00562
46a	22800-00602	22800-00611	22800-00611	22800-00611
46b	22800-00601	22800-00662	22800-00662	22800-00662
68	22900-02505	22900-02510	-	2 x 22900-02510

**GB**

**WIRING DIAGRAM**

**F**

**SCHEMA ELECTRIQUE**

**E**

**ESQUEMA ELECTRICO**

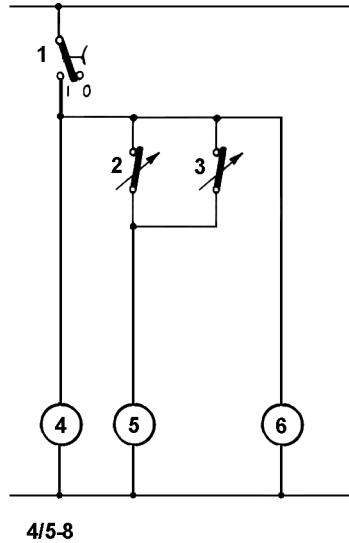
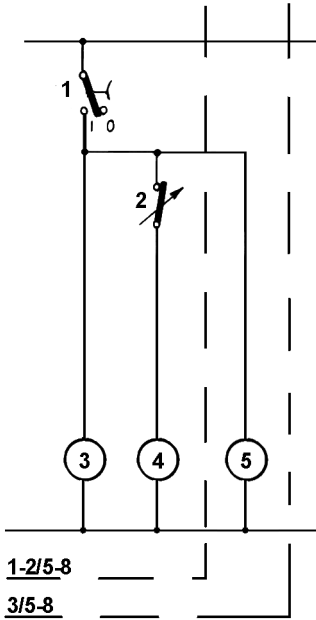

**1/5-8 - 2/5-8 - 3/5-8**

1	Switch	Interrupteur	Interruptor
2	Thermostat	Thermostat	Termostato
3-5	Pump/mixer	Pompe/brasseur	Bomba/agitador
4	Compressor	Compresseur	Motocompresor

**4/5-8**

1	Switch	Interrupteur	Interruptor
2-3	Thermostat	Thermostat	Termostato
4-6	Pump/mixer	Pompe/brasseur	Bomba/agitador
5	Compressor	Compresseur	Motocompresor

